

FUN WITH ENGLISH

ZABAVA S ENGLESKIM JEZIKOM

Ovo su predlošci riječi iz engleskog jezika koje svakodnevno koristimo. Od njih se može izraditi igra pamćenja, slagalica, a može ih se i obojati.

Pripremila: odgojiteljica Kristina Brežac Legović

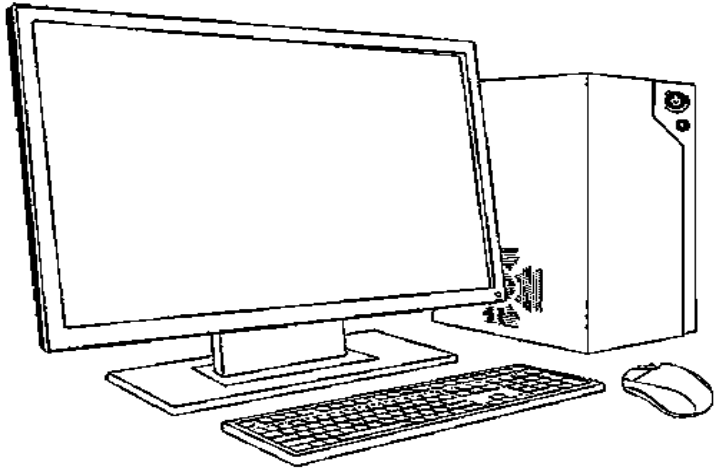

computer

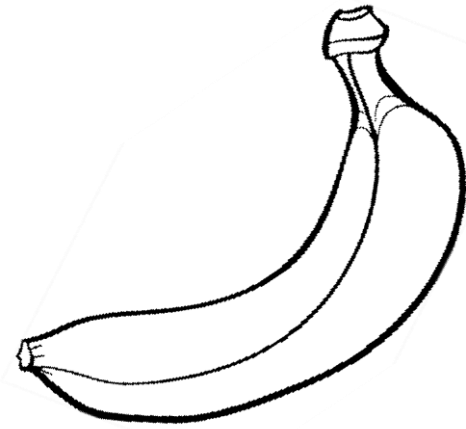

banana



doctor

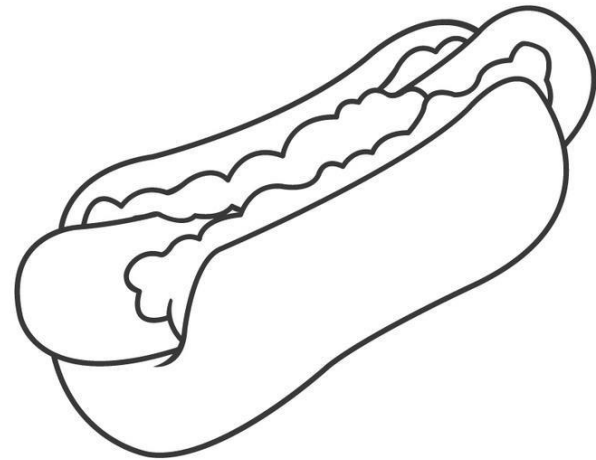

hot dog



telephone

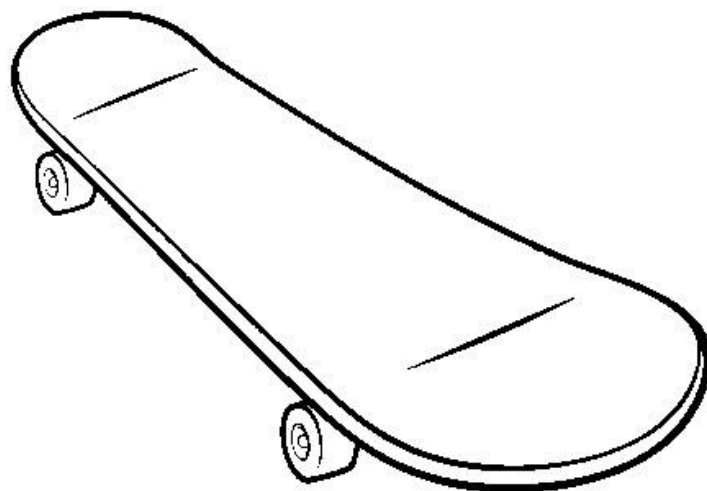

skateboard

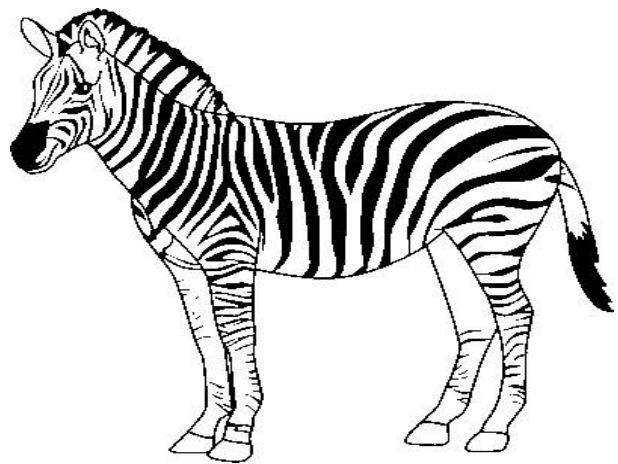

zebra

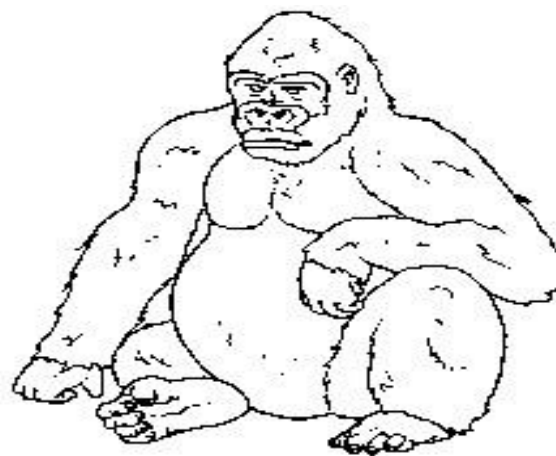

gorilla

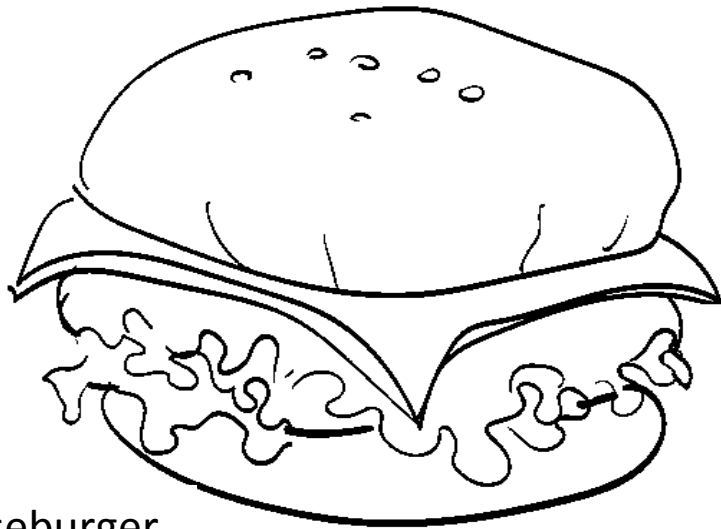

cheeseburger

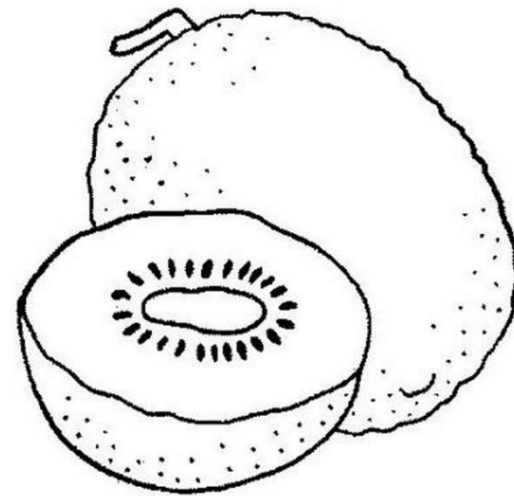

kiwi

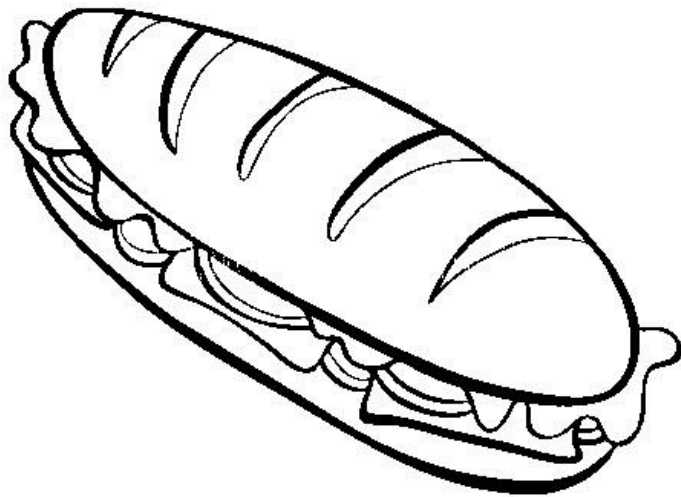

sandwich

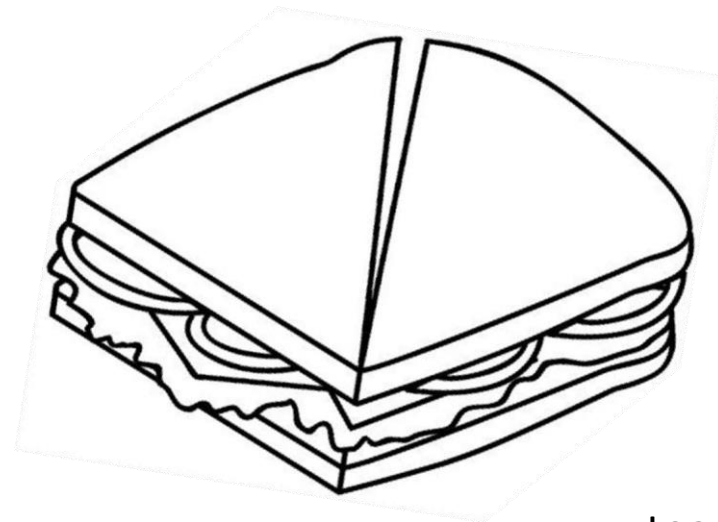

toast

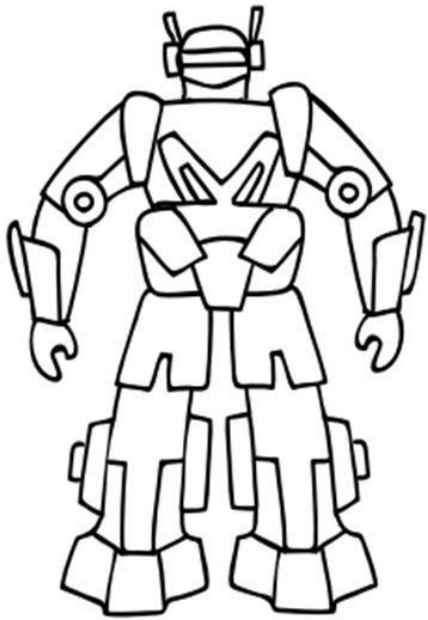

robot



pizza

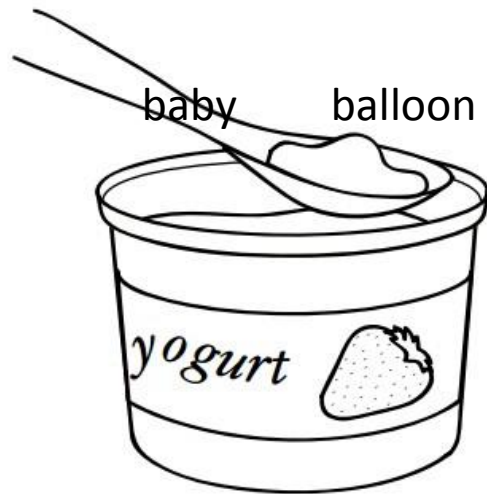

baby balloon

yoghurt

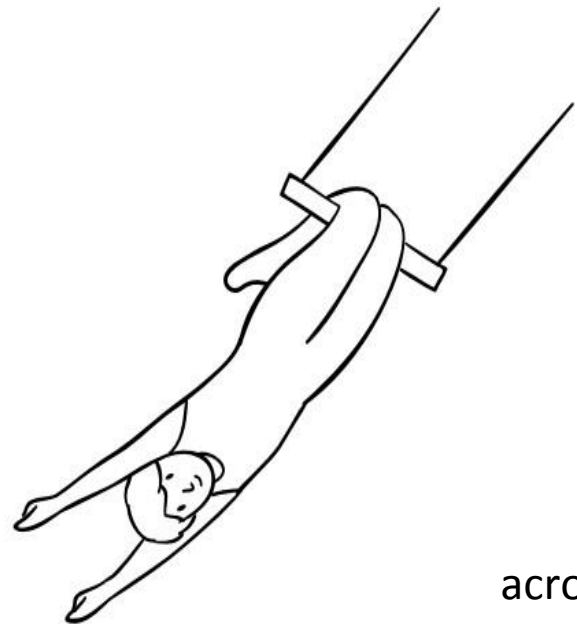

acrobat

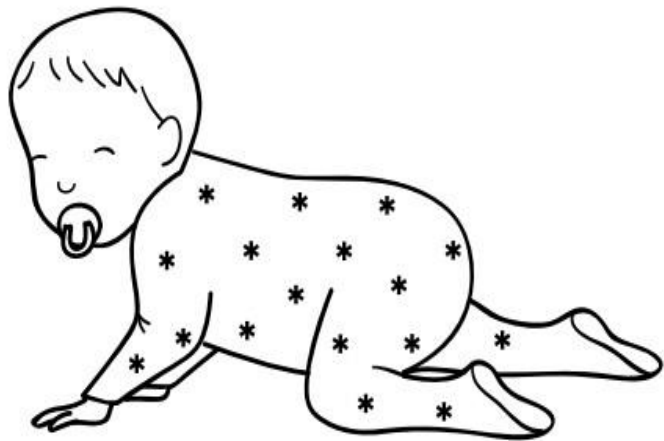

baby

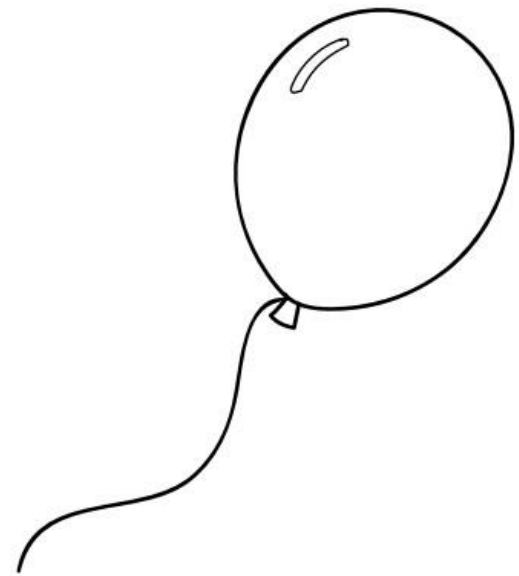

balloon

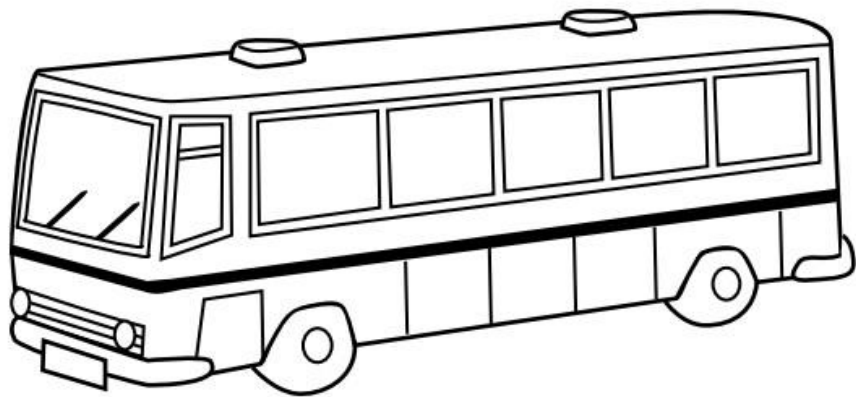

bus

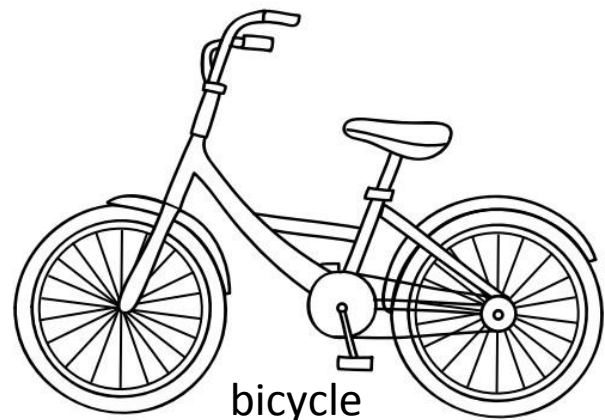

bicycle



blouse



broccoli



clown

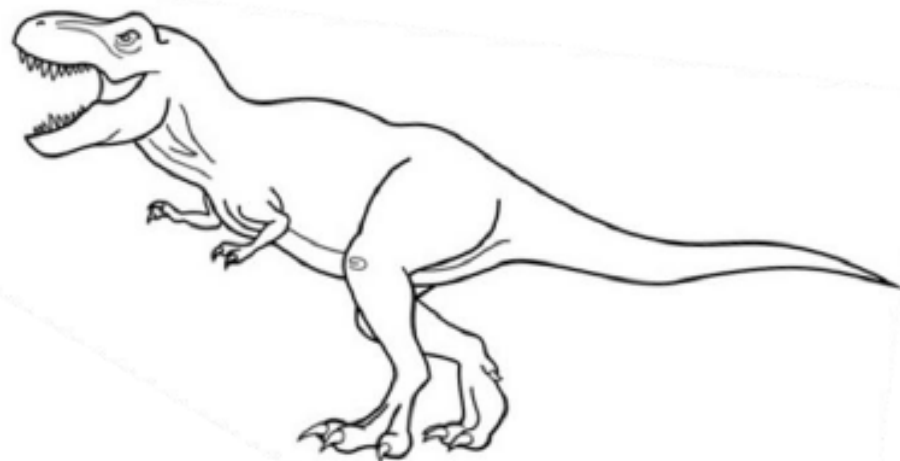

dinosaur

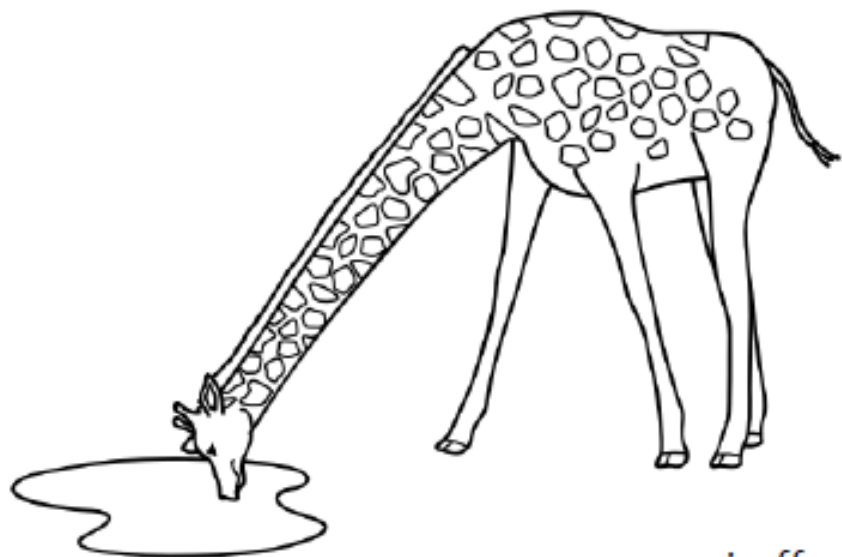

giraffe



guitar

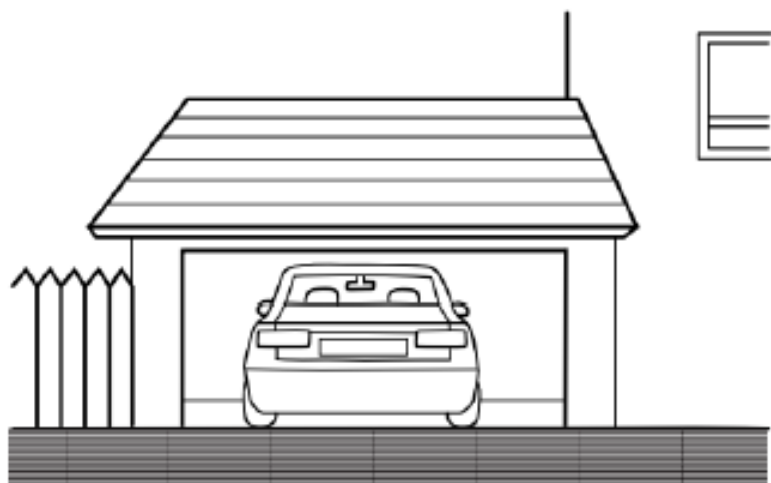

garage



globe



helicopter

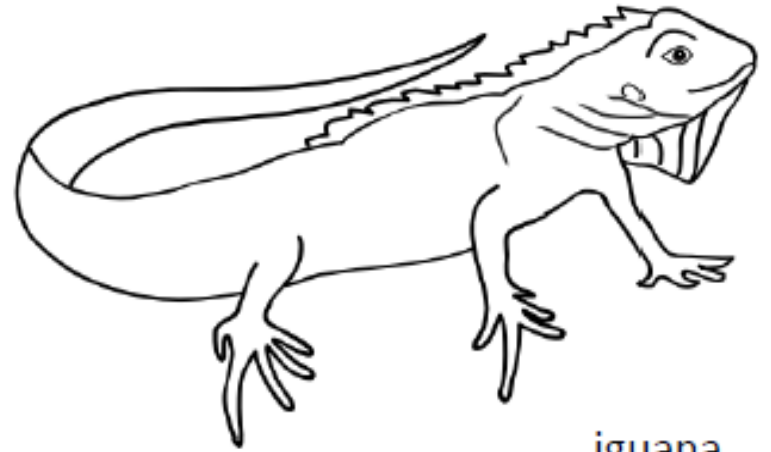

iguana

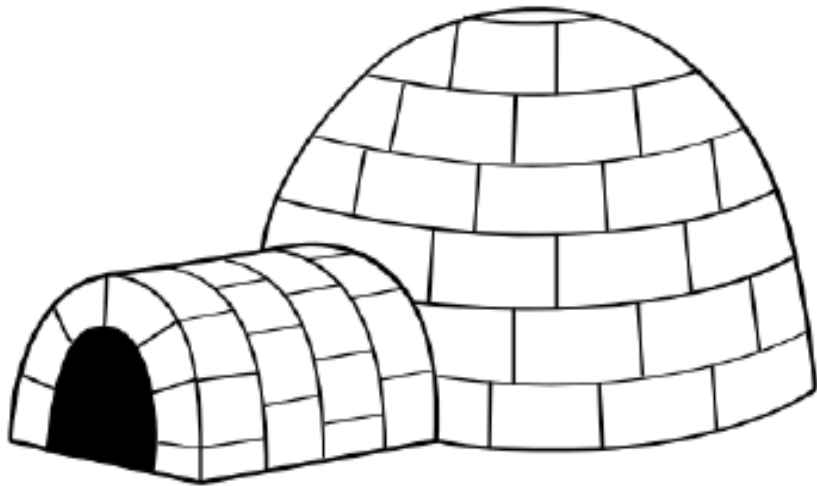

igloo



jam

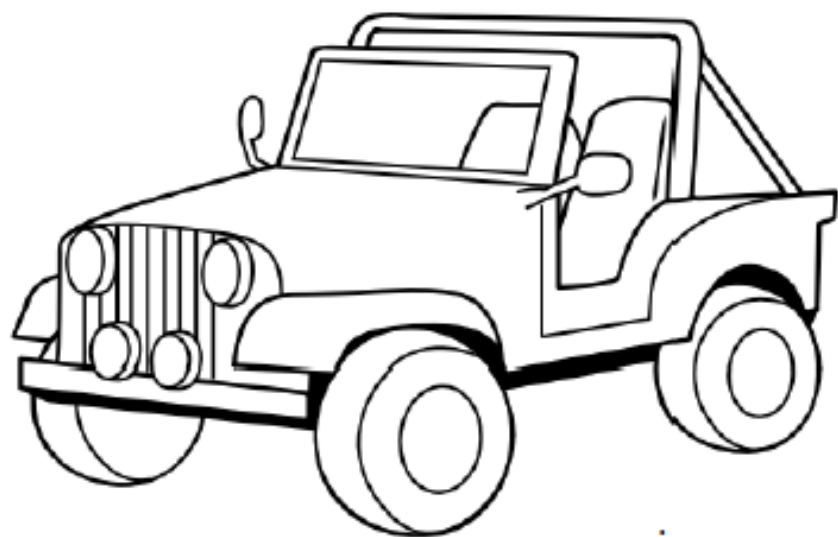

jeep

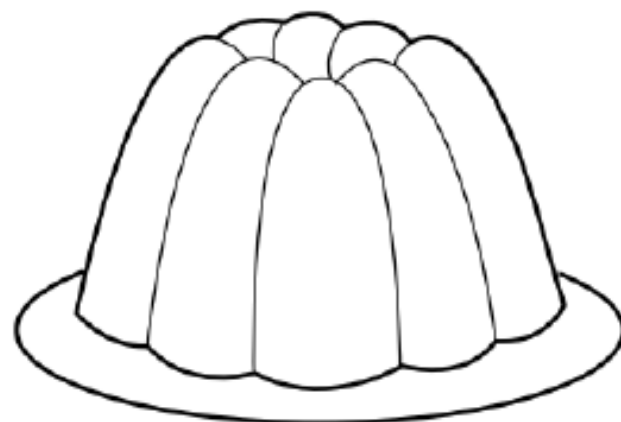

jelly



jaguar



koala

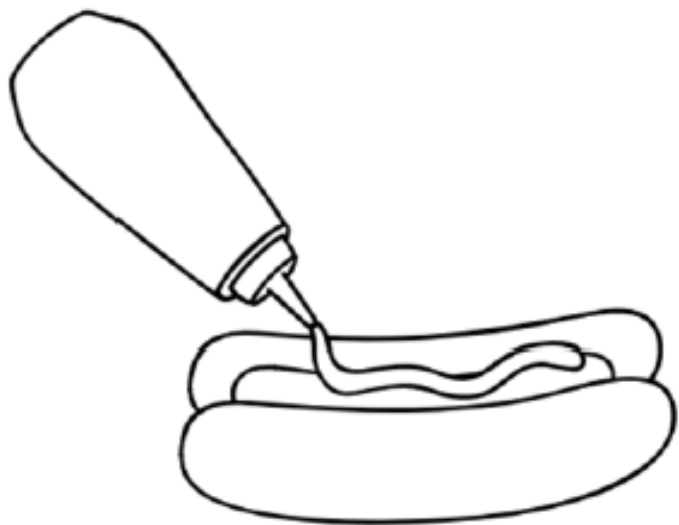

ketchup

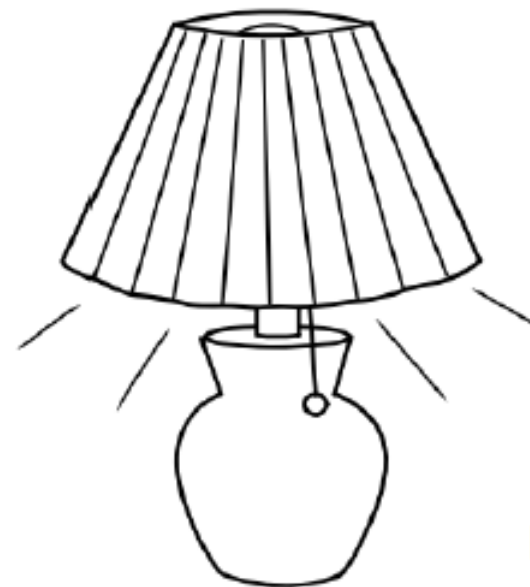

lamp

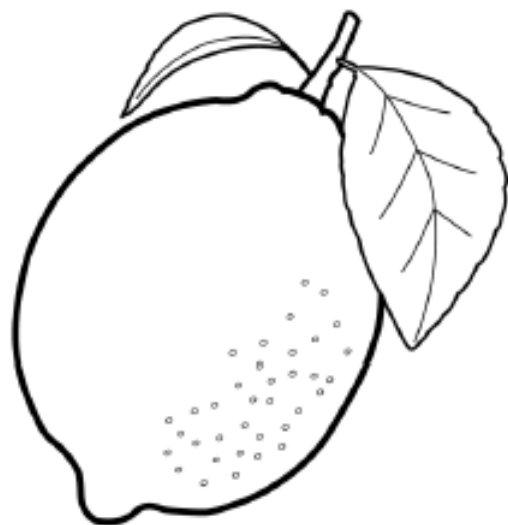

lemon

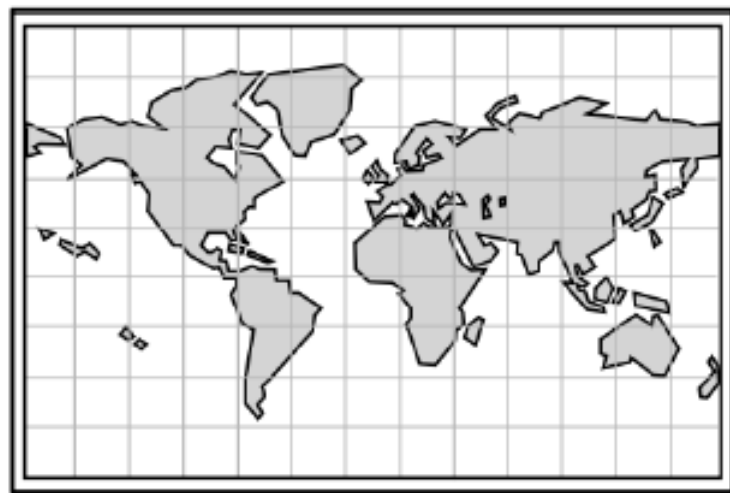

map



mask



mop

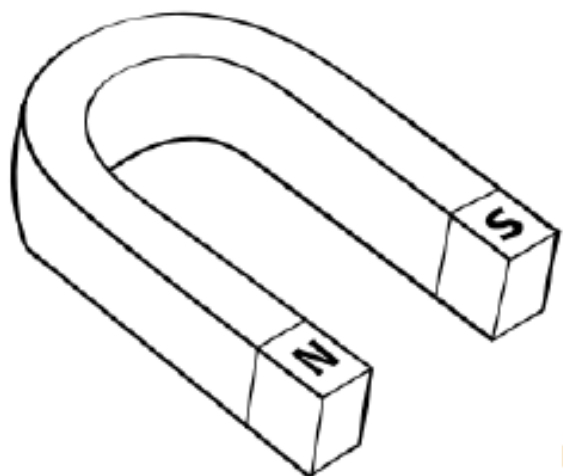

magnet



perfume



pirate

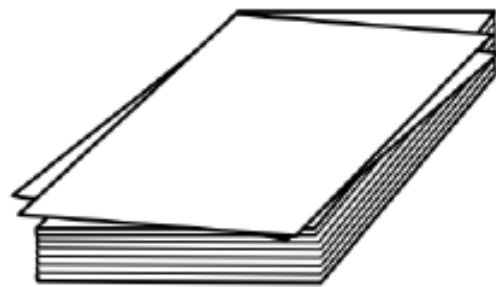

paper



princess



prince

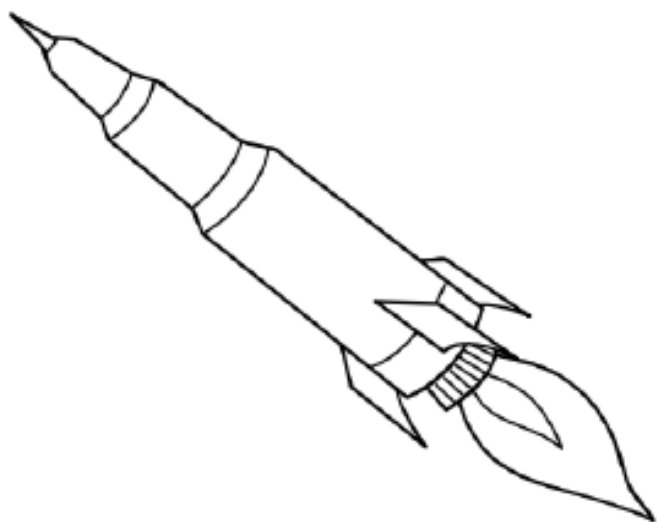

rocket

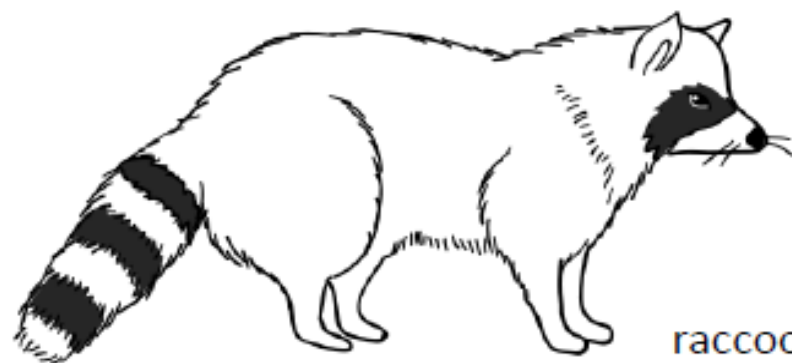

raccoon

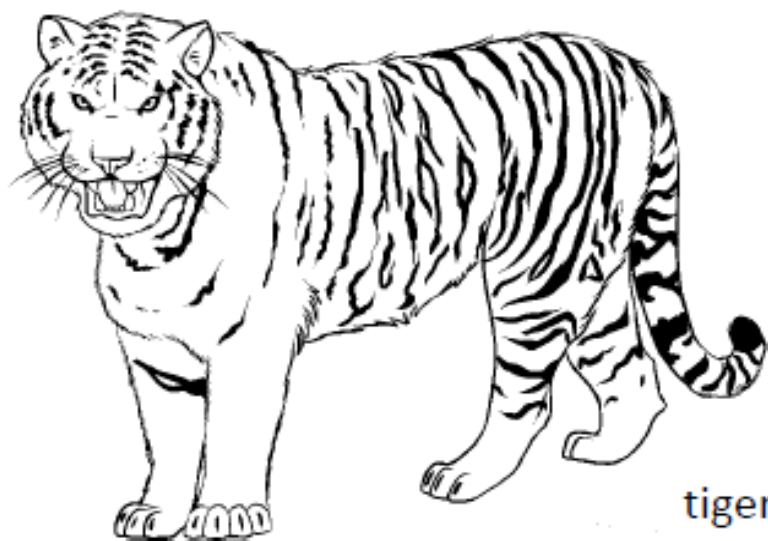

tiger



vase



violin

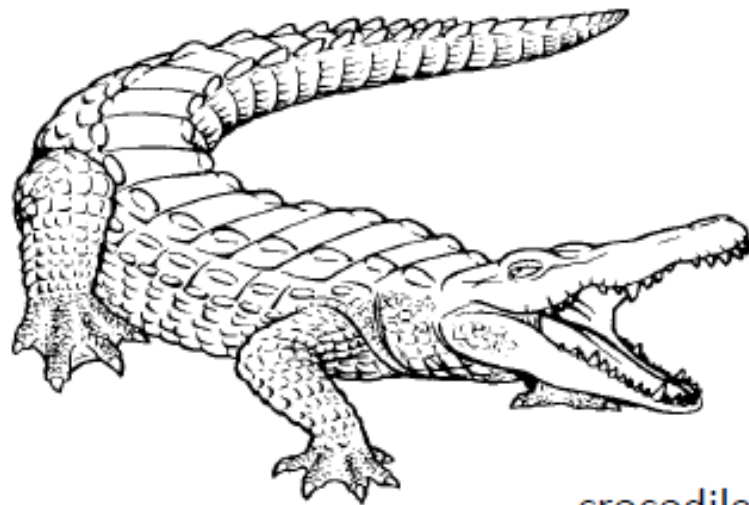

crocodile

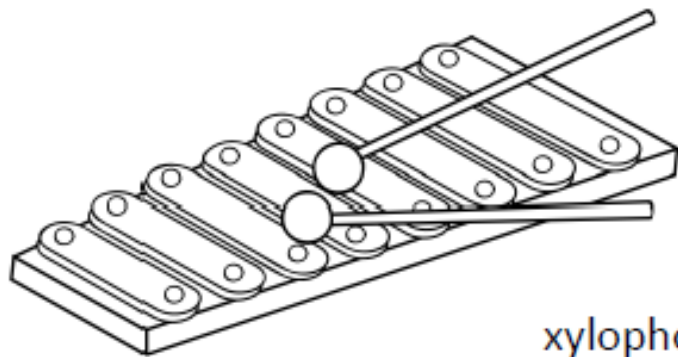

xylophone

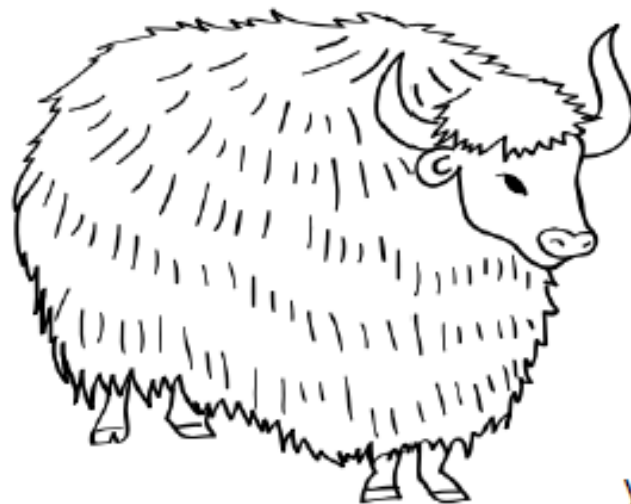

yak